



2022 PRODUCT GUIDE
WATER STORAGE RANGE



*FUEL PROOF LTD
MIDDLETON BUSINESS PARK
MIDDLETON ROAD
HEYSHAM
LANCASHIRE
LA3 3FH*

*TEL: +44 (0)1524 850685
WEB: WWW.FUELPROOF.CO.UK
EMAIL: SALES@FUELPROOF.CO.UK*

CONTENTS

ITEM	PAGE
● STATIC WATER TANKS	1
● HIGHWAY TOW WATER BOWSERS	3
● SITE TOW WATER BOWSERS	5
● HOT PRESSURE WASHER BOWSERS	7
● PRESSURE WASHER BOWSERS	9

1 STATIC WATER TANKS

FOR STORING AND TRANSPORTING WATER



GALVANISED TUBULAR STEEL BASE WITH INTEGRAL FORKLIFT POCKETS FOR EASY LIFTING & MOVING



BAFFLED TANK FOR IMPROVED STABILITY



SECURE LOCKABLE LID; 380MM DIAMETER MANWAY INTO TOP OF TANK FOR MAINTENANCE & CLEANING

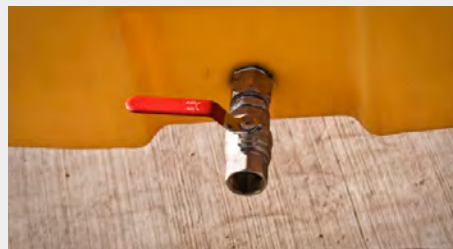

1" OUTLET AT FRONT AND REAR

OVERVIEW

Our 1,140 Litre (250 gallon) water storage tank provides an excellent solution for the storage, transport and dispensing of water. The heavy-duty polyethylene tank and galvanised tubular steel base are extremely tough and durable. The base also features integral forklift pockets for safe and easy moving. The large manway provides easy access to the tank for maintenance and cleaning. This product is ideal for many applications and industries including council and municipal, agriculture, construction, industrial, plant hire and domestic.

KEY FEATURES

- ▶ 1,140 litre (250 gallon) capacity
- ▶ Tough rotationally moulded UV stabilised polyethylene tank
- ▶ Tank mounted on a galvanised tubular steel base
- ▶ Baffled tank for improved stability in transit
- ▶ Integral forklift pockets for safe and easy lifting and moving
- ▶ Secure lockable lid
- ▶ Manway to access inside of tank for cleaning and maintenance

PRODUCT CODES

PRODUCT TYPE	CODE
1,140L Static Water Tank	1005
1,140L Static Water Tank <i>WRC approved for drinking water</i>	1025

TECHNICAL DETAILS

PRODUCT	LENGTH (mm)	WIDTH (mm)	HEIGHT (mm)	EMPTY WEIGHT (kg)	FULL WEIGHT (kg)
1,140L Static Water Tank	1,520	1,310	1,390	140	1,280
1,140L Static Water Tank <i>WRC approved for drinking water</i>	1,520	1,310	1,390	140	1,280

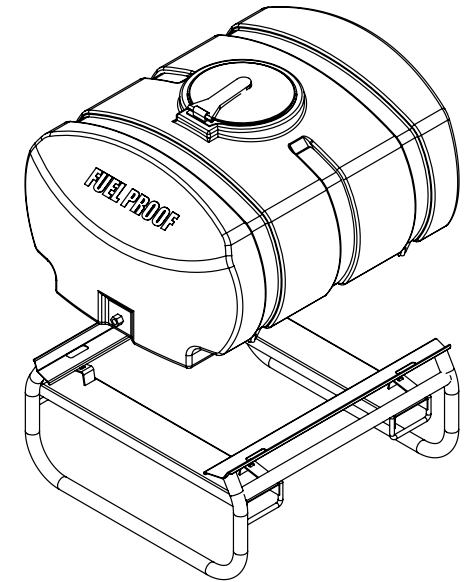

TOP VIEW



BOTTOM VIEW



END VIEW



INTERNAL TANK VIEW



SPECIFICATION

- ▶ 2" bottom outlet for easy cleaning of unit
- ▶ 1" outlet front and rear
- ▶ Tank fitted with breather
- ▶ 380mm diameter manway into top of tank
- ▶ Available with WRC-approved tank for drinking water

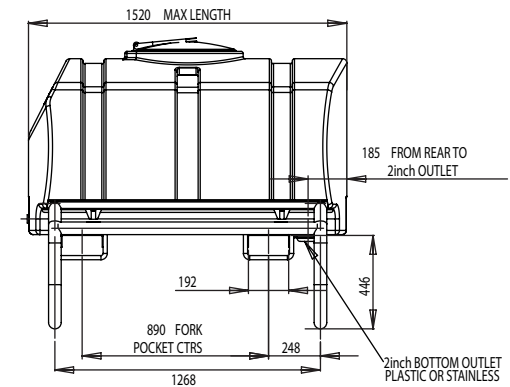
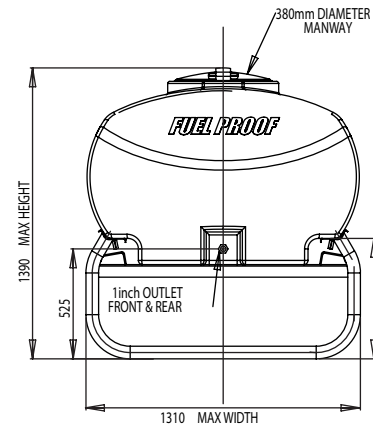

HIGHWAY TOW WATER BOWSERS

FOR STORING AND TRANSPORTING WATER



HIGHWAY TOW WATER BOWSERS FEATURE GALVANISED MUDGUARDS AND REAR LIGHTING BOARD



SINGLE-AXLE MODEL



1" OUTLET AT FRONT AND REAR



HIGHWAY-COMPLIANT LIGHTING



TWIN-AXLE MODEL

OVERVIEW

Our 1,140 Litre (250 gallon) highway tow water bowser range features a tough polyethylene tank mounted on a galvanised tubular steel chassis, and provides an excellent solution for transporting water safely and efficiently. Available in single- and twin-axle configuration, the low-profile design and baffled tank deliver excellent performance on the highway. The large manway provides easy access to the tank for maintenance and cleaning. This product is ideal for many applications and industries including council and municipal, agriculture, construction, industrial, plant hire and domestic.

KEY FEATURES

- ▶ 1,140 litre (250 gallon) capacity
- ▶ Tough rotationally moulded UV stabilised polyethylene tank
- ▶ Tank mounted on a galvanised tubular steel chassis
- ▶ Heavy-duty axles and running gear for long-term reliable service
- ▶ Baffled tank for improved stability in transit
- ▶ Secure lockable lid
- ▶ Manway to access inside of tank for cleaning and maintenance

PRODUCT CODES

PRODUCT TYPE	CODE Standard / For drinking water
1,140L Single Axle Highway Bowser	1010 / 1030
1,140L Twin Axle Highway Bowser	1015 / 1035

TECHNICAL DETAILS

PRODUCT	LENGTH (mm)	WIDTH (mm)	HEIGHT (mm)	EMPTY WEIGHT (kg)	FULL WEIGHT (kg)
Single Axle Highway Bowser	3,373	1,807	1,358	327	1,467
Twin Axle Highway Bowser	3,379	1,763	1,242	486	1,626

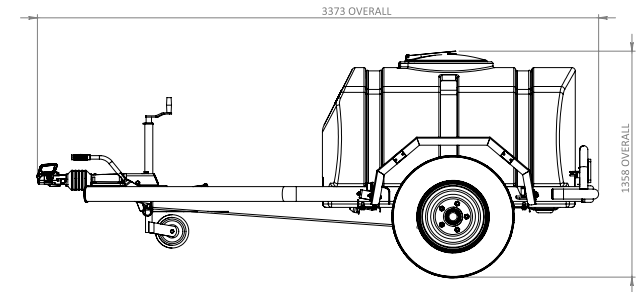

SINGLE AXLE MODEL:

TOP VIEW

BOTTOM VIEW

SIDE VIEW

REAR VIEW

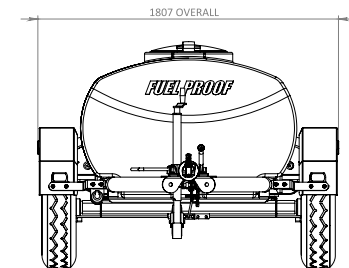
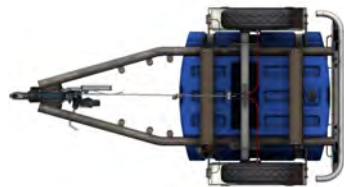
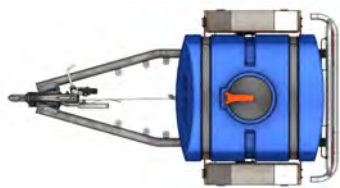

TWIN AXLE MODEL:

TOP VIEW

BOTTOM VIEW

SIDE VIEW

REAR VIEW

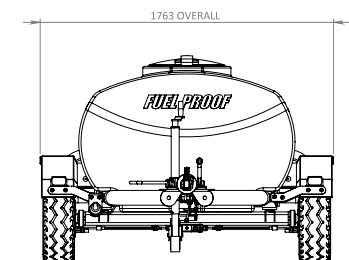
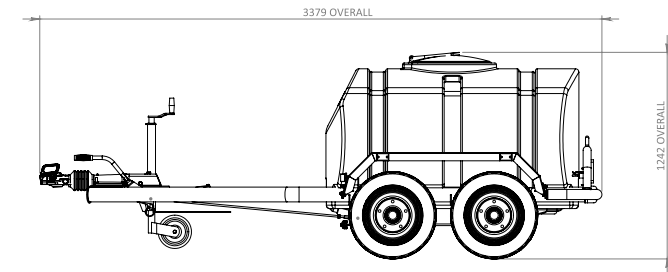
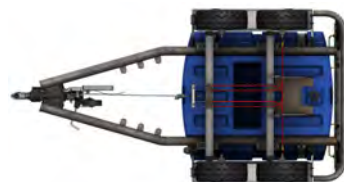
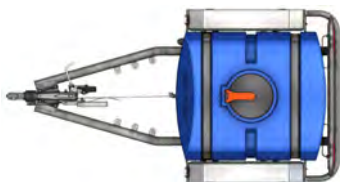

SPECIFICATION

- ▶ 2" bottom outlet for easy cleaning of unit
- ▶ 1" outlet front and rear
- ▶ Tank fitted with breather
- ▶ 380mm diameter manway into top of tank
- ▶ Available with WRC-approved tank for drinking water
- ▶ Overrun brakes, hitch and damper

SITE TOW WATER BOWSERS

FOR STORING AND TRANSPORTING WATER



1,140 LITRE SITE TOW WATER BOWSER



2,000 LITRE SITE TOW WATER BOWSER

NOTE: PUMP NOT INCLUDED AS STANDARD



HAND BRAKE & RING HITCH



SECURE LOCKABLE LID; MANWAY INTO TOP OF TANK FOR MAINTENANCE & CLEANING



OUTLET AT FRONT AND REAR

OVERVIEW

Our site tow water bowser range is ideally suited to many different industries including construction, plant hire, agriculture, council and municipal, industrial and domestic applications. These bowzers are fitted with a heavy duty polyethylene tank mounted on a galvanised tubular steel chassis, making them extremely tough and durable. Heavy duty running gear and large flotation tyres mean the bowzers are ideal for use on rough terrain.

KEY FEATURES

- ▶ Available in 1,140 and 2,000 litre capacities
- ▶ Tough rotationally moulded UV stabilised polyethylene tank
- ▶ Tank mounted on reinforced, galvanised tubular steel chassis
- ▶ Baffled tank for improved stability in transit
- ▶ Tough site specification with heavy duty running gear
- ▶ Secure lockable lid
- ▶ Manway to access inside of tank for cleaning and maintenance

PRODUCT CODES

PRODUCT TYPE	CODE
1,140L Site Tow Water Bowser	1020
1,140L Site Tow Water Bowser <i>WRC approved polymer for drinking water</i>	1040
2,000L Site Tow Water Bowser	1050
Dust Suppression Kit for 2,000L model inc. Pump / Spreader Plate	-

TECHNICAL DETAILS

PRODUCT	LENGTH (mm)	WIDTH (mm)	HEIGHT (mm)	EMPTY WEIGHT (kg)	FULL WEIGHT (kg)
1,140 Litre Site Tow Water Bowser	3,143	1,879	1,368	366	1,506
2,000 Litre Site Tow Water Bowser	4,064	2,002	1,747	725	2,725

1,140 LITRE MODEL:

TOP VIEW

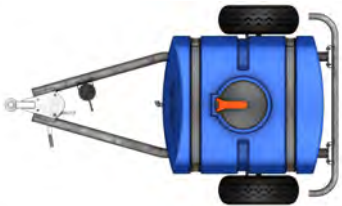

BOTTOM VIEW



SIDE VIEW



REAR VIEW

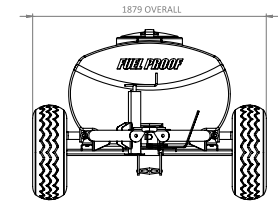
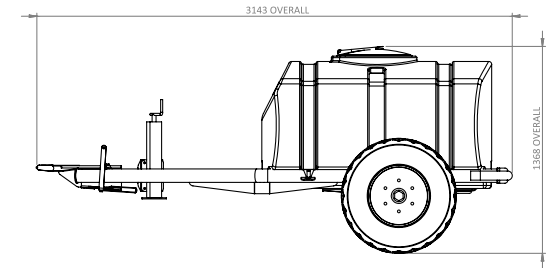

2,000 LITRE MODEL:

TOP VIEW



BOTTOM VIEW



SIDE VIEW



REAR VIEW

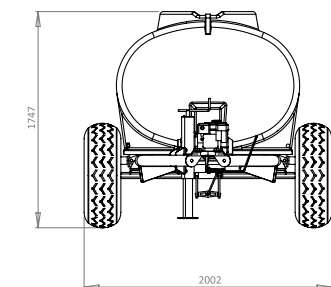
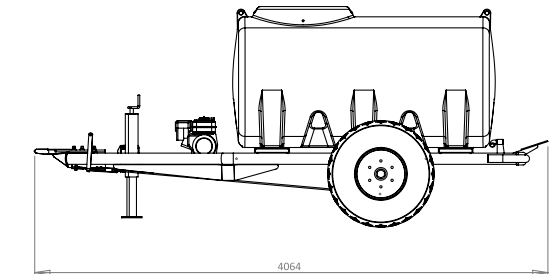

SPECIFICATION - 1,140 LITRE MODEL

- ▶ 2" bottom outlet for easy cleaning of unit
- ▶ 1" outlet front and rear; tank fitted with breather
- ▶ 380mm diameter manway into top of tank
- ▶ Available with WRC-approved tank for drinking water

SPECIFICATION - 2,000 LITRE MODEL

- ▶ 2" outlet
- ▶ 455mm diameter manway into top of tank
- ▶ Secure pin mounting system

HOT PRESSURE WASHER BOWSERS

THE ULTIMATE IN MOBILE CLEANING HARDWARE



HIGH-PERFORMANCE HEATED PRESSURE WASHER BOWSER FEATURING SECURE, BESPOKE ALUMINIUM PUMP CASING WITH GAS-STRUT ASSISTED OPENING



EASY-TOW DESIGN WITH FULL HIGHWAY APPROVAL AND INDESPENSION TWIN-AXLE RUNNING GEAR



DESIGNED AND MANUFACTURED SPECIFICALLY FOR APPROVED KÄRCHER CLEANING COMPONENTS



SECURE EQUIPMENT CABINET, HOUSING PUMP AND HIGH-OUTPUT BURNER WITH UPRIGHT COIL



LANCE HOLDER AND LOCKABLE HOSE REEL IN HARD-WEARING ELECTRO-PLATED STEEL

KÄRCHER

OVERVIEW

Exclusive to Fuel Proof, our Kärcher Hot Pressure Washer Bowser gives you fast, easy and superior cleaning – any time, anywhere. Developed in partnership with Kärcher, world leaders in high-performance cleaning hardware, this hot-wash bowser utilises the Kärcher Professional HDS 1000 DE hot wash system. Hot water at high pressure cleans with far more kinetic energy, vibrating stubborn dirt apart at the molecular level for faster and more thorough cleaning – saving you time and effort with every use.

KEY FEATURES

- ▶ Kärcher Professional HDS 1000 DE hot wash system
- ▶ Baffled twin-axle configuration with petrol or diesel option
- ▶ 1,140 litre (250 gallon) water bowser tank with filtered top-fill
- ▶ Heavy-duty polyethylene tank and galvanised tubular chassis
- ▶ Galvanised mudguards and rear lighting board
- ▶ Full highway approval, with high-quality running gear by Indespension
- ▶ 33L Antifreeze and detergent tanks included as standard
- ▶ Overrun brakes, hitch and damper

PRODUCT CODES

PRODUCT TYPE	CODE
Twin Axle 1,140L Hot Pressure Washer Bowser 13hp electric start petrol engine 15 L/min @ 200 bar	2904-000-KPW15P
Twin Axle 1,140L Hot Pressure Washer Bowser 10hp electric start diesel engine 15 L/min @ 200 bar	2904-500-KPW15D

TECHNICAL DETAILS

PRODUCT	LENGTH (mm)	WIDTH (mm)	HEIGHT (mm)	EMPTY WEIGHT (kg)	FULL WEIGHT (kg)
Twin Axle 1,140L Hot Pressure Washer Bowser <i>13hp electric start petrol engine 15 L/min @ 200 bar</i>	3,724	1,767	1,699	792	1,932
Twin Axle 1,140L Hot Pressure Washer Bowser <i>10hp electric start diesel engine 15 L/min @ 200 bar</i>	3,724	1,767	1,699	812	1,952

SPECIFICATION

- ▶ 1" outlet front and rear; tank fitted with breather
- ▶ 380mm diameter manway into top of tank
- ▶ Hand rewind hose reel
- ▶ Standard hose length 15 metres
- ▶ Secure lockable lid incorporating mesh filter basket
- ▶ Kärcher Professional lance for detergent application
- ▶ Lance holder
- ▶ Lighting system complies with highway regulations

TOP VIEW

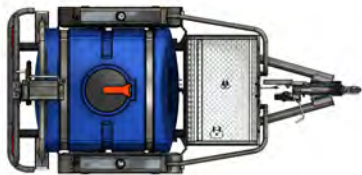

BOTTOM VIEW

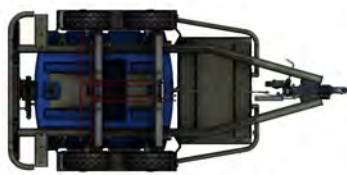

SIDE VIEW



REAR VIEW

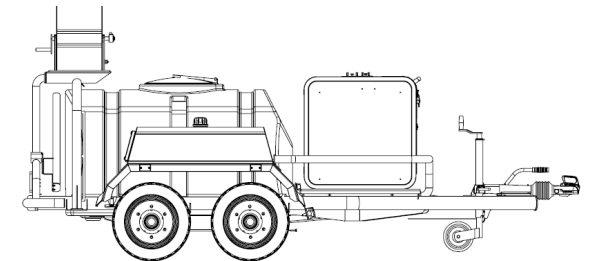

MADE IN BRITAIN: EXPERTLY DESIGNED IN SOLIDWORKS AND ASSEMBLED AT OUR UK FACILITY



SIDE REFLECTOR AND TRAILER LIGHTING CONNECTION



PETROL- AND DIESEL-ENGINED PUMP OPTIONS AVAILABLE

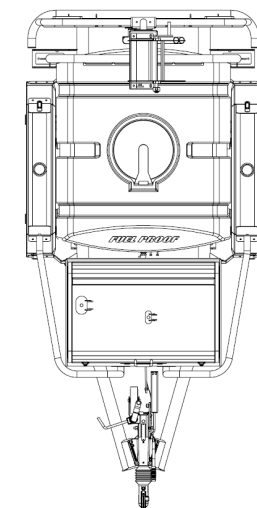

PRESSURE WASHER BOWSERS

A MOBILE CLEANING SYSTEM IDEAL FOR A WIDE RANGE OF APPLICATIONS



1,140 LITRE PRESSURE WASHER BOWSER



IDEAL FOR A WIDE RANGE OF CLEANING APPLICATIONS



GALVANISED CHASSIS WITH SIDE PROTECTION BARS AND PUMP MOUNTING PLATE



SECURE LOCKABLE LID INCORPORATING MESH FILTER BASKET; 380MM DIAMETER MANWAY INTO TOP OF TANK FOR MAINTENANCE AND CLEANING



LIGHTING SYSTEM COMPLIES WITH HIGHWAY REGULATIONS

OVERVIEW

Fuel Proof's range of mobile pressure washer bowzers provide the ultimate solution for plant cleaning, and are ideal for a wide range of industries including construction, agriculture, council and municipal, industrial and domestic applications. With a heavy-duty polyethylene tank and galvanised chassis, these mobile bowzers provide unrivalled strength and durability. Available in single axle and twin axle configuration, with a range of pressure washer units and other optional equipment available.

KEY FEATURES

- ▶ 1,140 litre (250 gallon) capacity
- ▶ Tough rotationally moulded polyethylene tank
- ▶ Tank mounted on a galvanised tubular steel chassis
- ▶ Baffled tank for improved stability in transit
- ▶ Galvanised mudguards and rear lighting board
- ▶ Secure lockable lid with manway to access inside of tank
- ▶ Twin high-speed axles
- ▶ Overrun brakes, hitch and damper

PRODUCT CODES

PRODUCT TYPE	CAPACITY	CODE
Twin Axle Pressure Washer Bowser 11hp electric start petrol engine 15 L/min @ 200 bar	1,140 litre	2905
Twin Axle Pressure Washer Bowser 10hp electric start diesel engine 15 L/min @ 200 bar	1,140 litre	2905

TECHNICAL DETAILS

PRODUCT	LENGTH (mm)	WIDTH (mm)	HEIGHT (mm)	EMPTY WEIGHT (kg)	FULL WEIGHT (kg)
Twin Axle Pressure Washer Bowser <i>11hp electric start petrol engine 15 L/min @ 200 bar</i>	3,404	1,762	1,236	466	1,606
Twin Axle Pressure Washer Bowser <i>10hp electric start diesel engine 15 L/min @ 200 bar</i>	3,404	1,762	1,236	486	1,626

SPECIFICATION

- ▶ 2" bottom outlet for easy cleaning of unit
- ▶ 1" outlet front and rear; tank fitted with breather
- ▶ 380mm diameter manway into top of tank
- ▶ Available with WRC approved tank for drinking water
- ▶ Lifting eyes at front and rear for easy lifting and moving
- ▶ Hand rewind hose reel with max. capacity 50m x 3/8" hose
- ▶ Standard hose length 20 metres
- ▶ Secure lockable lid incorporating mesh filter basket
- ▶ 2" bottom outlet for easy cleaning of unit. 1" outlet front & rear
- ▶ Standard lance with low pressure for soap application
- ▶ Turbo lance for extra high pressure cleaning
- ▶ Lance holder
- ▶ Lighting system complies with highway regulations

TOP VIEW

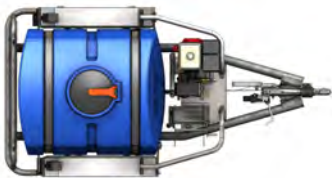

BOTTOM VIEW

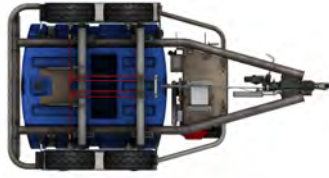

SIDE VIEW



REAR VIEW

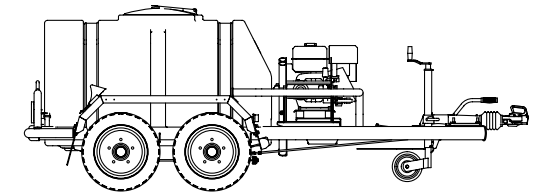

GALVANISED MUDGUARDS WITH SIDE REFLECTORS



SIDE REFLECTOR AND TRAILER LIGHTING CONNECTION



HAND REWIND HOSE REEL WITH MAX. CAPACITY 50M X 3/8" HOSE

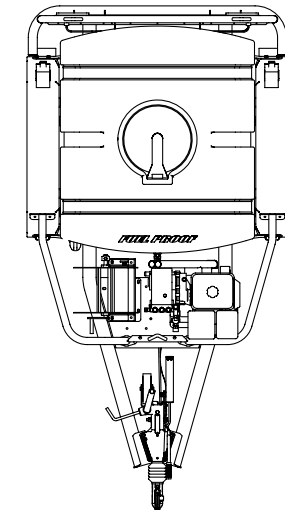



Stainless steel tanks for
detergent and anti-freeze



20m Hose kit upgrade
25m Hose kit upgrade
30m Hose kit upgrade



Spare wheel & carrier



Wheel chocks & holders

When selecting multiple additional options, please contact our team to ensure your combination is compatible.



*FUEL PROOF LTD
MIDDLETON BUSINESS PARK
MIDDLETON ROAD
HEYSHAM
LANCASHIRE
LA3 3FH*

*TEL: +44 (0)1524 850685
WEB: WWW.FUELPROOF.CO.UK
EMAIL: SALES@FUELPROOF.CO.UK*