

E METERS CONFIGURATION

Some models of meter feature a menu with which the user can select the main measurement unit, Quarts (Qts), Pints (Pts), Litres (Lit), Gallons (Gal). The combination of the unit of measurement of the Partial register and that of the Totals is predefined according to the following table:

Combination no.	Unit of Measurement of the Partial Register	Register Unit of Measurement of the Totals Register
1	Litres (L)	Litres (L)
2	Gallons (Gal)	Gallons (Gal)
3	Quarts (Qts)	Gallons (Gal)
4	Pints (Pts)	Gallons (Gal)

To choose between the 4 available combinations:

- wait for K24 to go to Standby.
- press the CAL and RESET keys together. Keep these pressed until the word "UNIT" appears on the screen together with the unit of measurement set at that time (in this example Litres / Litres)
- Press the reset key to select the desired combination of unit of measurement, amongst those shown below.
- Save the new combination by pressing the cal key at length. K24 will pass through the start cycle and will then be ready to dispense in the set units.

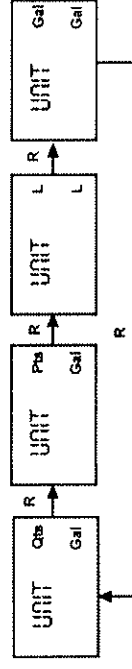

WARNING
The Resettable Total and Total registers will be automatically changed to the new unit of measurement. NO new calibration is required after changing the Unit of Measurement.

F MAINTENANCE

K24 has been designed to require a minimum amount of maintenance. The only types of maintenance required are the following:

1. Battery change – necessary when the batteries have run down
2. Cleaning of the turbine with washing or mechanically-handling

1 Battery Replacement

K24 is complete with 2 x 1.5 V. alkaline batteries SIZE AAA.

K24 features two low-battery alarm levels:

- 1) When the battery charge falls below the first level on the LCD, the fixed battery symbol appears.

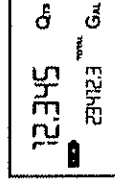

In this condition, K24 continues to operate correctly, but the fixed icon warns the user that it is ADVISABLE to change the batteries.

- 2) If K24 operation continues without changing the batteries, the second battery alarm level will be reached which will prevent operation. In this condition the battery icon starts to flash and is the only one to remain visible on the LCD.

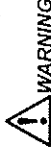
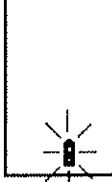

WARNING
Do not discard the old batteries in the environment. Refer to local disposal regulations.

To change the batteries, with reference to the exploded diagram positions, proceed as follows:

- Press RESET to update all the totals
- Loosen the 4 fixing screws of the lower cover
- Remove the old batteries
- Place the new batteries in the same position as the old ones
- close the cover again, by positioning the rubber protection as a gasket
- K24 will switch on automatically and normal operation can be resumed.

The K24 will display the same Reset Total, the same Total and the same Partial indicated before the batteries were changed.

After changing the batteries, the meter does not need calibrating again.

2 Cleaning

Only one operation is necessary to clean the k24. After removing k24 from the plant where it was built in, any residual elements can be removed by washing or mechanically-handling. If this operation does not restore a smooth rotation of the turbine, it will have to be replaced.



WARNING:
Do not use compressed air onto the turbine in order to avoid its damage because of an excessive rotation

G. MALFUNCTIONS

Problem	Possible Cause	Azione Correttiva
LCD: no indication	Bad battery contact	Check battery contacts
Not enough measurement precision	Wrong K FACTOR	With reference to paragraph H, check the K FACTOR
	The meter works below minimum acceptable flow rate.	Increase the flow rate until an acceptable flow rate range has been achieved
Reduced or zero flow rate	TURBINE blocked	Clean the TURBINE
The meter does not count, but the flow rate is correct	Incorrect installation of gears after cleaning	Repeat the reassembly procedure
	Possible electronic card problems	Contact your dealer

H TECHNICAL SPECIFICATIONS

Measurement system		TURBINE
Resolution (nominal)	Hi Flow	0.010 lit/pulse
	Low Flow	0.005 lit/pulse
Flow Rate (Range)	K24 COL BLACK Flow-rates:	5 ÷ 120 (Litres/minute) FOR DIESEL FUEL, WATER..
	K24 COL BEIGE Flow-rates	5 ÷ 100 (Litres/minute) FOR WATER/ UREA SOLUTION..
Operating pressure (Max)		10 (Bar) 145 (psi)
Bursting pressure (Min)		40 (Bar)
Storage temperature (Range)		-20 ÷ + 70 (°C)
Storage humidity (Max)		95 (% RH)
Operating temperature (Range)		-10 ÷ + 50 (°C)
Flow resistance		0.30 Bar at 100 lit/min.
Viscosity (Range)		2 ÷ 5.35 cSt
Accuracy		± 1% after calibration within 10-90 (litres/min) 2.65-23.8 (gallons/min) range
Reproducibility (Typical)		± 0.3 (%)
Screen		Liquid crystals LCD. Featuring: - 5-figure partial - 6-figure Reset Total plus x10 / x100 - 6-figure non reset Total plus x10 / x100
Power Supply		2x1.5 V alkaline batteries size AAA
Battery life		18 ÷ 36 months
Weight		0.25 Kg (included batteries)
Protection		IP65

I DISPOSAL

The components must be given to companies that specialise in the disposal and recycling of industrial waste and, in particular, the

DISPOSAL OF PACKAGING.

The packaging consists of biodegradable cardboard which can be delivered to companies for normal recycling of cellulose.

DISPOSAL OF METAL COMPONENTS

The metal components, both painted and stainless steel, are usually recycled by companies that are specialised in the metal-scraping industry.

DISPOSAL OF ELECTRIC AND ELECTRONIC COMPONENTS:

these have to be disposed by companies that are specialised in the disposal of electronic components, in accordance with the instructions of 2002/96/EC (see text of Directive below).

ENVIRONMENTAL INFORMATION FOR CUSTOMERS IN THE EUROPEAN UNION



European Directive 2002/96/EC requires that the equipment bearing this symbol on the product and/or its packaging must not be disposed of with unsorted municipal waste. The symbol indicates that this product should be disposed of separately from regular household waste streams. It is your responsibility to dispose of this and other electric and electronic equipment via designated collection facilities appointed by the government or local authorities.

DISPOSAL OF OTHER PARTS:

The disposal of other parts such as pipes, rubber seals, plastic components and cables should be entrusted to companies that special in the disposal of industrial waste.

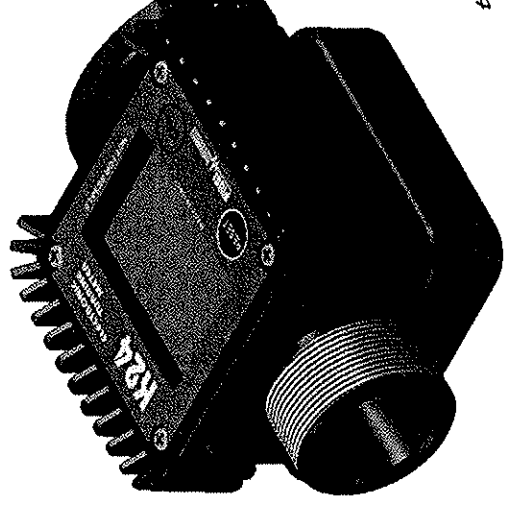
K24
ELECTRONIC TURBINE
METER

PIUSI
think genius

MANUALE D'USO, MANUTENZIONE
E CALIBRAZIONE

USE, MAINTENANCE AND
CALIBRATION MANUAL

Italiano

English

Bulletin MO171A1TEN rev.1

DECLARATION OF CONFORMITY

The undersigned, representing the following manufacturer
Piusi S.p.A.
45029 - Suzzara (Mantova) - Italy

CERTIFIES

that the equipment described below:
K24

complies with the following directives:

2004/108/CE (Electromagnetic Compatibility Directive)
and following amendments

Ottolavini
President

Suzzara 01.07.2009

A6 Battery Housing

The k24 is powered by two standard type 1.5 V batteries (size AAA). The battery housing, easily accessible, is closed by a metal cover sealed through a rubber protection acting as a gasket as well. The whole unit can be easily removed by unscrewing the 4 screws fixing the cover and the protection to the body.

B INSTALLATION

K24 features a threaded, perpendicular inlet and outlet (1" gas or ntp male and female that can be combined together). It has been designed to be easily installed in any position: fixed in-line or mobile on a dispensing nozzle. In order to improve the life of the turbine, it is recommended to fit a strainer before the meter itself.

! ATTENTION

At the female inlets, **tighten the couplings at a max. torque of 55N/m.**

! ATTENTION:

WITH THE GAS-FEMALE INLETS, DO NOT USE CONICAL THREADED COUPLINGS.

C DAILY USE

The only operations that need to be done for daily use are partial and/or resettable total register resetting. The user should use only the dispensing system of k24. Occasionally the meter may need to be configured or calibrated. To do so, please refer to the relevant chapters.

Below are the two typical normal operation displays. The other shows the partial and general total. Switchover from resettable total to general total display is automatic and tied to phases and times that are in factory set and cannot be changed.

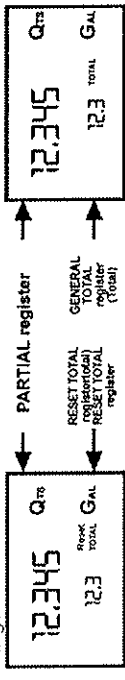

NOTE: 6 digits are available for Totals, plus two icons x 10 / x100. The increment sequence is the following:
 0.0 → 99999.9 → 999999 → 100000 x 10 → 999999 x 10 → 100000 x 100 → 999999 x 100

C1 Dispensing in Normal mode

Normal mode is the standard dispensing. While the count is made, the partial and resettable total are displayed at the same time (reset total).

Should one of the keys be accidentally pressed during dispensing, this will have no effect. A few seconds after dispensing has ended, on the lower register, the display switches from resettable total to general total: the word reset above the word total disappears, and the reset total is replaced by the general total. This situation is called standby and remains stable until the user operates the k24 again.

C1.1 Partial reset

The partial register can be reset by pressing the reset key when the meter is in standby, meaning when the display screen shows the word "TOTAL".

After pressing the reset key, during reset, the display screen first of all shows all the lit-up digits and then all the digits that are not lit up.

At the end of the process, a display page is first of all shown with the reset partial and the reset total:

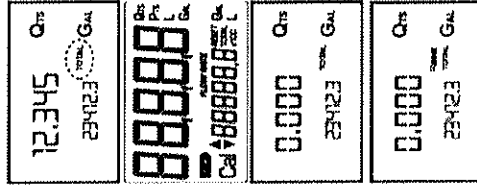

and, after a few moments, the reset total is replaced by the non resettable Total.

C1.2 Resetting the Reset Total

The reset total resetting operation can only be performed after resetting the partial register. The reset total can in fact be reset by pressing the reset key at length while the display screen shows reset total as on the following display page:

Schematically, the steps to be taken are:

1. Wait for the display to show normal standby display page (with total only displayed).
2. Press the reset key quickly
3. The meter starts to reset the partial
4. While the display page showing the reset total is displayed Press the reset key again for at least 1 second
5. The display screen again shows all the segments of the display followed by all the switched-off segments and finally shows the display page where the reset Reset Total is shown.

C.2 Dispensing with Flow Rate Mode display

It is possible to dispense fluids, displaying at the same time: the dispensed partial the Flow Rate in [Partial Unit / minute] as shown on the following display page:



Procedure for entering this mode:
 - wait for the Remote Display to go to Standby, meaning the display screen shows Total only
 - quickly press the CAL key.

The flow rate is updated every 0.7 seconds. Consequently, the display could be relatively unstable at lower flow rates. The higher the flow rate, the more stable the displayed value.

! IMPORTANT

The flow rate is measured with reference to the unit of measurement of the Partial. For this reason, in case of the unit of measurement of the Partial and Total being different, as in the example shown below, it should be remembered that the indicated flow rate relates to the unit of measurement



of the partial. In the example shown, the flow rate is expressed in Qts/min. The word "Gal" remaining alongside the flow rate refers to the register of the Totals (Reset or NON Reset) which are again displayed when exiting from the flow rate reading mode.

To return to "Normal" mode, press the CAL key again. If one of the two keys RESET or CAL is accidentally pressed during the count, this will have no effect.

! IMPORTANT

Even though in this mode they are not displayed, both the Reset Total and the General Total (Total) increase. Their value can be checked after dispensing has terminated, returning to "Normal" mode, by quickly pressing CAL.

C.2.1 Partial reset

To reset the Partial Register, finish dispensing and wait for the Remote Display to show a Flow Rate of 0.0 as indicated in the illustration then quickly press RESET

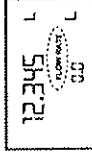
**D CALIBRATION****D1 Definitions**

Calibration factor or "k factor": Multiplication factor applied by the system to the electrical pulses received, to transform these into measured fluid units.

FACTORY K FACTOR:

Factory-set default factor. It is equal to 1.000. This calibration factor ensures utmost precision in the following operating conditions:

Fluid: diesel fuel

Temperature: 20°C

Flow rate: 10-120 litres/min

Even after any changes have been made by the user, the factory k factor can be restored by means of a simple procedure.

USER K FACTOR:

Customized calibration factor, meaning modified by calibration.

D2 Why Calibrate

When operating close to extreme conditions, such as for instance with fluids close to acceptable range extremes (like diesel fuel at low temperatures) or in extreme flow rate conditions (close to minimum or maximum acceptable values), an on-site calibration may be required to suit the real conditions in which the k24 is required to operate.

D3 Calibration procedure:

K24 permits making quick and precise electronic calibration by changing the calibration factor (K factor).

There are 2 different ways of calibration:

1. On-site calibration, performed by means of a dispensing operation.
2. Direct calibration, performed by directly changing the k factor.

To enter the calibration phases it is necessary to press and hold down the "cal" button.

Why enter the calibration phases?

- Display the currently used calibration factor
- Return to factory k factor after a previous calibration with user k factor
- Change the calibration factor using one of the two previously indicated procedures.

In calibration mode, the partial and total dispensed quantities indicated on the display screen take on different meanings according to the calibration procedure phase. During the calibration, the k24 cannot perform any normal dispensing operations. In calibration mode, the totals are not increased.

! WARNING

The k24 features a non-volatile memory. It keeps the calibration and dispensing data stored even after replacing new batteries or long periods of inactivity.

D3.1 Display Of Current "K Factor" And Restoring "Factory K Factor"

By pressing the cal key while the appliance is in standby, the display page appears showing the current calibration factor used:

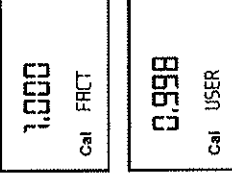

If you are using k24 with "factory k factor", the display page shown in the diagram will be displayed, with the word "fact".

If one "user k factor" has been set, the calibration factor set by the user (in our example 0.998) will be displayed. The word "user" indicates a calibration factor set by the user is being used.

LEGEND:

R+R long RESET

R short RESET

C+C long CAL

C short CAL

⊙ Time Out

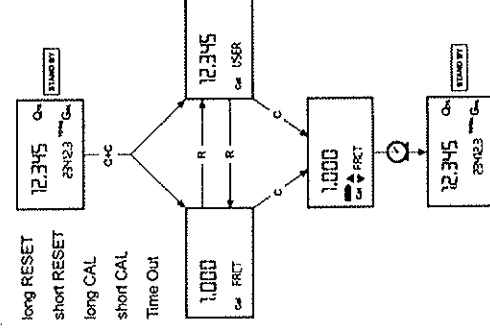

The flow chart alongside shows the switchover logic from one display page to another.

In this condition, the Reset key permits switching from User factor to Factory factor.

To confirm the choice of calibration factor, quickly press CAL while "User" or "Fact" are displayed.

After the restart cycle, the meter uses the calibration factor that has just been confirmed.

! ATTENTION

When the Factory Factor is confirmed, the old User factor is deleted from the memory

D3.2 In-field Calibration

This procedure calls for the fluid to be dispensed into a graduated sample container in real operating conditions (flow rate, viscosity, etc.) requiring maximum precision.

! WARNING

For correct K24 calibration, it is most important to:

- completely eliminate air from the system before calibrating;
- use a precise Sample Container with a capacity of not less than 5 litres, featuring an accurate graduated indicator.
- ensure calibration dispensing is done at a constant flow rate equivalent to that of normal use, until the container is full;
- not reduce the flow rate to reach the graduated area of the container during the final dispensing stage (the correct method during the final stages of sample container filling consists in making short top-ups at normal operation flow rate);
- after dispensing, wait a few minutes to make sure any air bubbles are eliminated from the sample container; only read the Real value at the end of this stage, during which follow the procedure indicated below.
- if necessary, carefully follow the procedure indicated below.

D3.2.1 In-field calibration procedure:

AZIONE	DISPLAY
1 NONE K24 IN STAND BY	12.345 Qm 12.5 GAL
2 LONG CAL KEY KEYING K24 enters calibration mode, shows "CAL" and displays the calibration factor in use instead of total. The words "Fact" and "USER" indicate which of the two factors is currently in use.	1.000 FRCT CAL (USER)
3 LONG RESET KEY KEYING K24 shows "CAL" and the partial at zero. K24 is ready to perform on-site calibration.	0.000 CAL FELD
4 DISPENSING INTO SAMPLE CONTAINER Without pressing any KEY, start dispensing into the sample container. Dispensing can be interrupted and started again at will. Continue dispensing until the level of the fluid in the sample container has reached the graduated area. There is no need to reach a preset quantity. 9.86 Indicated value Real value	9.800 CAL FELD
5 SHORT RESET KEY KEYING K24 is informed that the calibration dispensing operation is finished. Make sure dispensing is correctly finished before performing this operation. To calibrate the K24, the value indicated by the partial totaliser (example 9.800) must be forced to the real value marked on the graduated sample container. In the bottom left part of the display an arrow appears (upwards and downwards). THAT SHOWS the direction (increase or decrease) of the USER K FACTOR value change when the operations 6 or 7 are performed.	9.800 CAL FELD
6 SHORT RESET KEY KEYING Arrow direction changes. The operation can be repeated IF NECESSARY	9.800 CAL FELD

7 SHORT/LONG CAL KEY KEYING The indicated value changes in the direction indicated by the arrow one unit for every short CAL key keying -continually if the CAL key is kept pressed. (for the first 5 units slowly and then quickly). If the desired value is exceeded, repeat the operations from point (6).	9.860 CAL FRCT
8 LONG RESET KEY KEYING K24 is informed that the calibration procedure is finished. Before doing this, make sure the DISPLAYED factor is the ACTUAL factor. Indicated value Real value 9.860 CAL FRCT	9.860 CAL FRCT
9 NO OPERATION At the end of the calculation, the new USER K FACTOR is shown for a few seconds, after which the restart cycle is repeated to finally achieve standby condition. ATTENTION: From now on, the indicated factor will become the calibration factor used by the meter and will continue to remain such even after a battery change	1.015 CAL FRCT
10 NO OPERATION K24 stores the new calibration factor and is ready for dispensing, applying the newly defined USER K FACTOR.	0.000 CAL 12345 Qm GAL

D3.3 Direct modification of K factor

This procedure is especially useful to correct a "mean error" obtainable on the basis of several performed dispensing operations, if normal K24 operation shows a mean percentage error; this can be corrected by applying to the currently used calibration factor a correction of the same percentage. In this case, the percentage correction of the USER K FACTOR must be calculated by the operator in the following way:

$$\text{New K Factor} = \text{Old K Factor} \cdot \left(\frac{100 - E\%}{100} \right)$$

Example:

Error percentage found E% -0.9 %

CURRENT calibration factor 1.000

New USER K FACTOR $1.000 \cdot \left[\frac{100 - (-0.9)}{100} \right] = 1.009$

If the meter indicates less than the real dispensed value (negative error) the new calibration factor must be higher than the old one as shown in the example. The opposite applies if the meter shows more than the real dispensed value (positive error).

OPERATION	DISPLAY
1 NONE K24 in STAND BY: not in counting mode.	12.345 Qm 12345 GAL
2 LONG CAL KEY KEYING K24 enters calibration mode, shows "CAL" and displays the calibration factor being used instead of the partial. The words "Fact" and "USER" indicate which of the two factors (factory or user) is currently being used.	1.000 FRCT CAL (USER)
3 LONG RESET KEY KEYING K24 shows "CAL" and the partial at zero. K24 is ready to perform on-site calibration by dispensing.	12.345 Qm CAL FELD
4 LONG RESET KEY KEYING We now go on to Direct change of the calibration factor: the word "Direct" appears together with the Currently Used calibration factor in the bottom left part of the display, an arrow appears (upwards or downwards) defining the direction (increase or decrease) of change of the displayed value when subsequent operations 5 or 6 are performed.	1.000 CAL DIRECT
5 SHORT RESET KEY KEYING Arrow direction changes. The operation can be repeated to alternate the direction of the arrow.	1.000 CAL DIRECT
6 SHORT/LONG CAL KEY KEYING The indicated value changes in the direction indicated by the arrow one unit for every short CAL key keying. -continually if the CAL key is kept pressed. The speed increase needs to be reached on the key pressed. If the desired value is exceeded, repeat the operations from point (6).	1.003 CAL DIRECT
7 LONG RESET KEY KEYING K24 is informed that the calibration procedure is finished. Before performing this operation, make sure the indicated value is that required.	1.003 CAL DIRECT
8 NO OPERATION At the end of the calculation, the new USER K FACTOR is shown for a few seconds, after which the restart cycle is repeated to finally achieve standby condition. ATTENTION: From now on, the indicated factor will become the calibration factor used by the meter and will continue to remain such even after a battery change.	1.003 CAL FRCT
9 NO OPERATION The K24 stores the new work calibration factor and is ready to begin dispensing, using the USER K FACTOR that has just been calculated.	0.000 CAL 12345 Qm GAL

INDEX

A BECOMING ACQUAINTED WITH K24
 A1 Measurement System
 A2 Display Positioning
 A3 Operating modes
 A4 LCD display
 A5 User Buttons
 A6 Battery Housing

B INSTALLATION
 C DAILY USE
 C1 Dispensing in Normal mode
 C1.1 Partial reset
 C1.2 Resetting the Reset Total
 C2 Dispensing with Flow Rate Mode display
 C2.1 Partial reset

D CALIBRATION
 D1 Definitions
 D2 Why Calibrate
 D3 Calibration procedure:
 D3.1 "Factory K Factor"
 D3.2 In-field Calibration
 D3.3 Direct modification of K factor

E METERS CONFIGURATION
 F MAINTENANCE
 G MALFUNCTIONS
 H TECHNICAL SPECIFICATIONS
 I DISPOSAL
 L EXPLODED VIEWS AND OVERALL DIMENSIONS

A BECOMING ACQUAINTED WITH K24

Electronic digital meter featuring a turbine measurement system, designed for precise measuring of low viscosity fluids, it is divided into two using macrogroups:

- 1 With body made of nonconductive plastic material of light colour, designed to be used with water / urea solution
- 2 With body made of conductive plastic material of dark colour (assessed resistance: 50 ohm), designed to be used with DIESEL FUEL, WATER and windscreen fluids.

The card can be rotated with respect to its housing, thus allowing easy display readings in any position. The card housing, easily accessible, is closed by a plastic cover sealed through a rubber protection acting as a gasket as well. The whole unit can be easily removed by unscrewing the 4 screws fixing the card and the cover.

A1 Measurement System

Turbine measurement system. The turbine is placed inside a hole through the body of K24, fitted with threaded inlet and outlet. The body of K24 is made of a plastic material that allows several types of threads with relevant combinations. K24 has 2 rubber protections, designed to act as gaskets, too, and thus reducing the number of its components.

The liquids compatible with K24 must be at low viscosity, namely:

- Diesel fuel
- Water
- Water/urea solution
- Kerosene
- Windscreen
- Petrol

Main components:

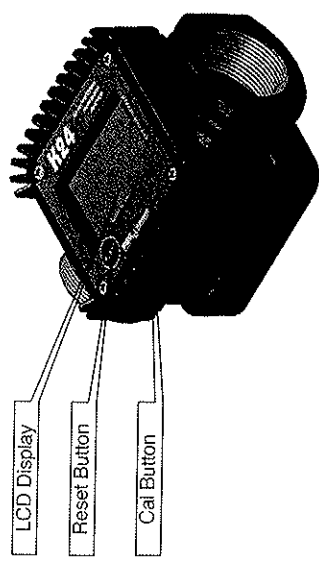

A2 Display Positioning

The square shape of the K24 body allows the card to be rotated in its housing, thus ensuring great versatility in positioning.

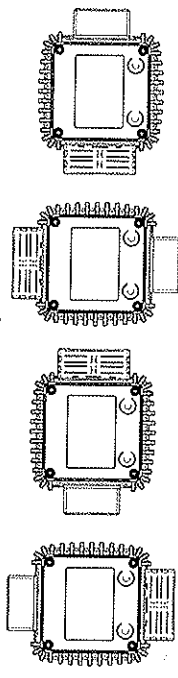

ATTENTION

While fixing the K24 card, make sure the battery contact cable is not placed above the circular housing of the bulb.

A3 Operating modes

The user can choose between two different operating modes:

- Normal Mode: Mode with display of Partial and Total dispensed quantities.
- Flow Rate Mode: Mode with display of Flow Rate, as well as Partial dispensed quantity.

The meter features a non-volatile memory for storing the dispensing data, even in the event of a complete power break for long periods. The measurement electronics and the LCD display are fitted in the top part of the K24 which remains isolated from the fluid-bath measurement chamber and sealed from the outside by means of a cover.

A4 LCD display

The "LCD" of the METER features two numerical registers and various indications displayed to the user only when the applicable function so requires.

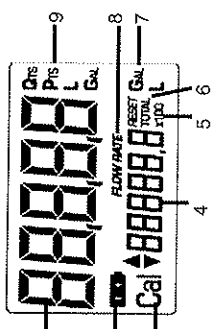

Key:

1. Partial register (5 figures with moving comma FROM 0.1 to 999999) indicating the volume dispensed since the reset button was last pressed;
2. Indication of battery charge;
3. Indication of calibration mode;
4. Totals register (6 figures with moving comma FROM 0.1 to 9999999), that can indicate two types of Total:
 - 4.1. General Total that cannot be reset (TOTAL)
 - 4.2. Resettable total (Reset TOTAL)
5. Indication of total multiplication factor (x10 / x100)
6. Indication of type of total, (TOTAL / Reset TOTAL);
7. Indication of unit of measurement of Totals: L=Litres Gal=Gallons
8. Indication of unit of measurement of Partial: Qts=Quarts
Pts=Pints
L=Litres
Gal=Gallons
- 9.

A5 User Buttons

The K24 features two buttons (reset and cal) which individually perform two main functions and, together, other secondary functions. The main functions performed are:

- For the reset key, resetting the partial register and resettable total (reset total)
 - For the cal key, entering instrument calibration mode.
- Used together, the two keys permit entering configuration mode, useful for changing the units of measurements and calibration factor.